



# Digital Display Solution 2024



# What does the industry need for digital media today?

## Organizational Challenges Faced Today

Lack of dedicated handling

Between Marcomm, Product/Brand, Content, and IT, who should take charge?

IT team is too busy and unable to address digital media tasks



## STARTUP & SME company

To have comprehensive digital signage capabilities, yet they want to utilize standard home TVs.

Software solutions from China or Korea lack a clear roadmap, features, and local support.

Discover how our digital signage solutions can empower your business to achieve its goals.



**Then, what is the suitable CMS (Content Management System) software?**

**Some software vendors are incomplete!**



**Software vendors and brands have no local support!**

**Several LCD brands have different software each!**

**Software from China, lacks roadmap / features, and local support**



**We Need this for our Digital Media in our company**

- **Software that can manage hundreds of thousands of layers, various brands, and even videotrons.**
- **Look for a vendor that provides a complete solution, from sales to installation and managed services.**
- **The company requires options for purchase, rent, and even inquiring about managed services.**
- **A Digital Signage partner that can meet diverse, evolving, and dynamic business needs.**

# InnoGRAPH offers various solution services as follows:

**Various Business Models:** in the form of sales services, rental of Digital Media Display, support, consultation, systems integration, specific/customer requirements, and even up to full managed services.

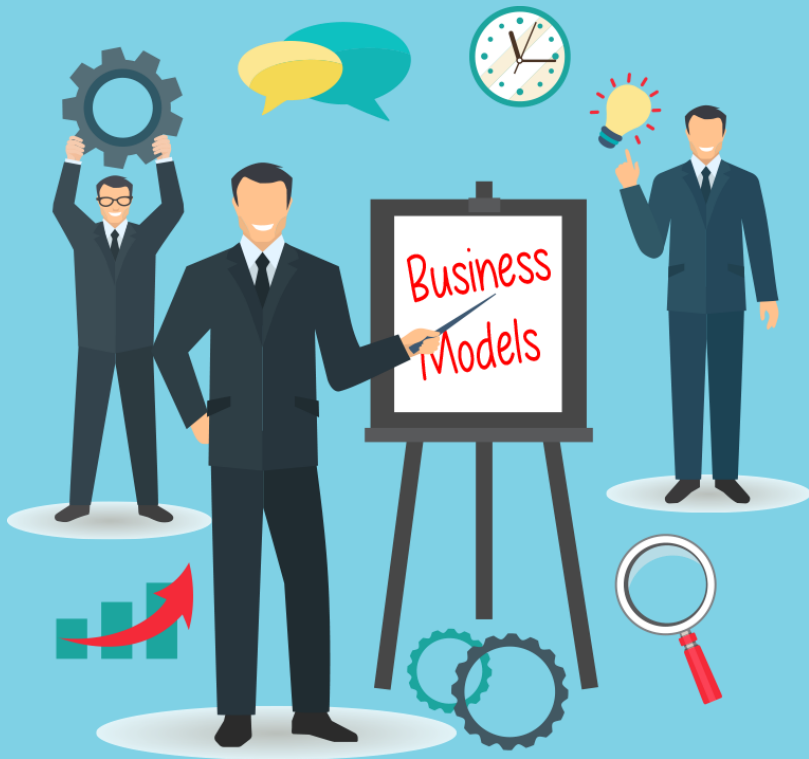

**Media Display Services (MDS):** monthly paid digital media display rental services, supported by DigiSIGN Play CMS and various other services for periods of 12/24/36 months.

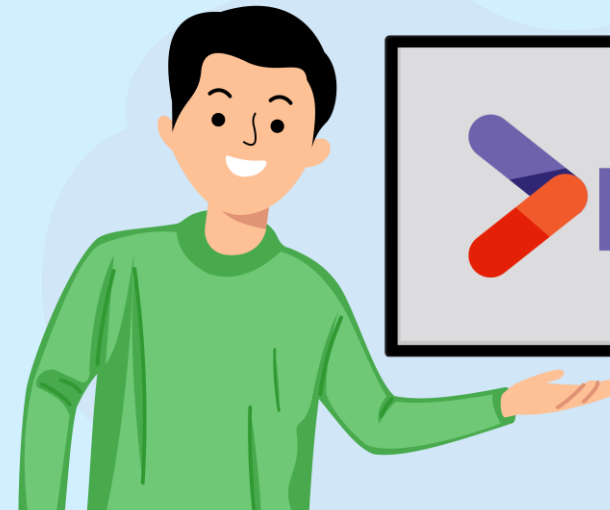

**DigiSIGN Play:** CMS software for all types of Digital Media (LCD) from various brands, operating systems, including LED Videotrons, with complete capabilities supporting small, medium, and large customer-based LCD.

# Various types of services and support



**One contracts for all**



**installation services**



**content updates\***



**comprehensive managed services  
or outsourced operations in the  
field of digital media.**

**And also,  
explore other digital  
media solutions (Kiosks,  
Interactive Flat Panels,  
Podiums, etc.)  
from InnoGRAPH.**

**Display Options:  
We provide LCD and  
LED (Videotron)  
digital display  
options for various  
usage needs,  
with demos/samples  
available for prototyping,  
and part of our stock  
ready for installation.**

# What is Digisign play ?

Digisign play is a new cloud-based CMS solution used to easily manage content on your digital signage network through a web browser. Digisign play is a solution for various industries, such as F&B, hospitality, education, corporate, manufacturing, and more



## Feature Digisign play:

- Display Management-Device Management
- 3-methods publish content to player
- Default Layout
- Scheduling Layout
- Schedule Campaign
- Interface & Experience friendly user
- Simple-Touchscreen display supported
- Grouping for player and media display
- Control your own reports
- Choose your own schedule for content
- Screenshot display for checking latest content
- Proof of play for advertising (optional)
- Detail display device information

## Digisign play CMS implementation on digital display

Feature	TV HDMI with USB	TV android / android box low cost	TV with android box	Professional display
Timer ON/Off	X	X	✓	✓
Screen Rotation	X	X	✓	✓
Content transition	X	✓	✓	✓
Auto start apps	X	✓	✓	✓
Remote desktop	X	✓	✓	✓
Device monitoring	X	✓	✓	✓



# **The digital display options from InnoGRAPH**



**DIGISIGN  
LED DIGITAL BANNER**  
**PAGE: 9**



**SMALL DISPLAY &  
WALL MOUNT**  
**PAGE: 13-14**



**CONSUMER (HOME) TV  
AS DIGITAL MEDIA**  
**PAGE: 18**



**DIGISIGN LED DIGITAL  
BANNER OUTDOOR**  
**PAGE: 10**



**DIGISIGN  
DUAL SIDE HANGING LCD**  
**PAGE: 15**



**INFOSIGN /  
DIGITAL MENU BOOK**  
**PAGE: 19**

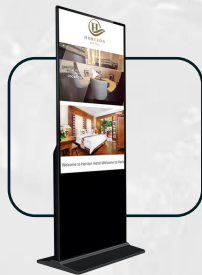

**DIGISIGN  
SLIM FLOORSTAND LITE**  
**PAGE: 11**



**LIFT MEDIA DISPLAY**  
**PAGE: 16**



**PORTABLE SMART  
TOUCH DISPLAY**  
**PAGE: 20**



**DIGISIGN FLOORSTAND**  
**PAGE: 12**

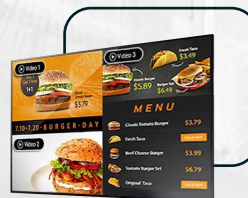

**PROFESSIONAL/  
COMMERCIAL DISPLAY**  
**PAGE: 17**

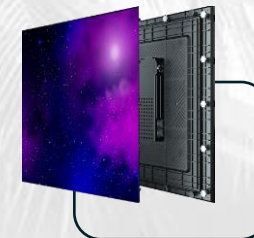

**QSTECH  
LED VIDEOTRON INDOOR**  
**PAGE: 22**





**QSTECH LED VIDEOTRON INDOOR FOR RETAIL**  
**PAGE: 23**

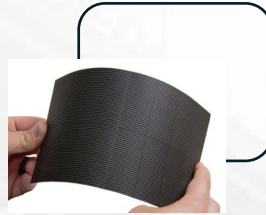

**LED FLEXIBLE DISPLAY (SPECIAL SHAPE)**  
**PAGE: 28**



**DIGISIGN DIGITAL TEACHING STATION**  
**PAGE: 35**



**VIDEOTRON FOR MEETING ROOMS, CONFERENCES HALL, AUDITORIUM**  
**PAGE: 24**



**LED DISPLAY CUSTOM SHAPE**  
**PAGE: 29**



**DIGITAL PODIUM**  
**PAGE: 36**

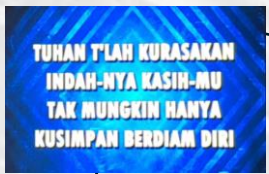

**VIDEOTRON FOR PLACES OF WORSHIP**  
**PAGE: 25**



**SHELF HEADER LED DISPLAY OUTDOOR**  
**PAGE: 30**



**SPECIAL STRETCH LCD DISPLAY**  
**PAGE: 31**



**DIGISIGN SMART AI ORDERING KIOSK**  
**PAGE: 37**



**VIDEOTRON FOR GENERAL USE**  
**PAGE: 26**

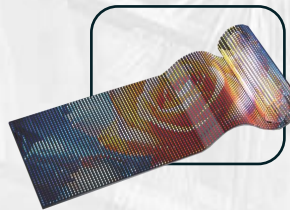

**LED TRANSPARANT SERIES**  
**PAGE: 32**



**LED VIDEOTRON OUTDOOR**  
**PAGE: 27**

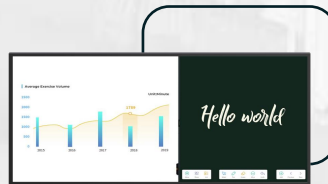

**COMMAND CENTER / CONTROL ROOM DISPLAY**  
**PAGE: 33**



**ICE BOARD X SERIES**  
**PAGE: 38**



**Dimension:**

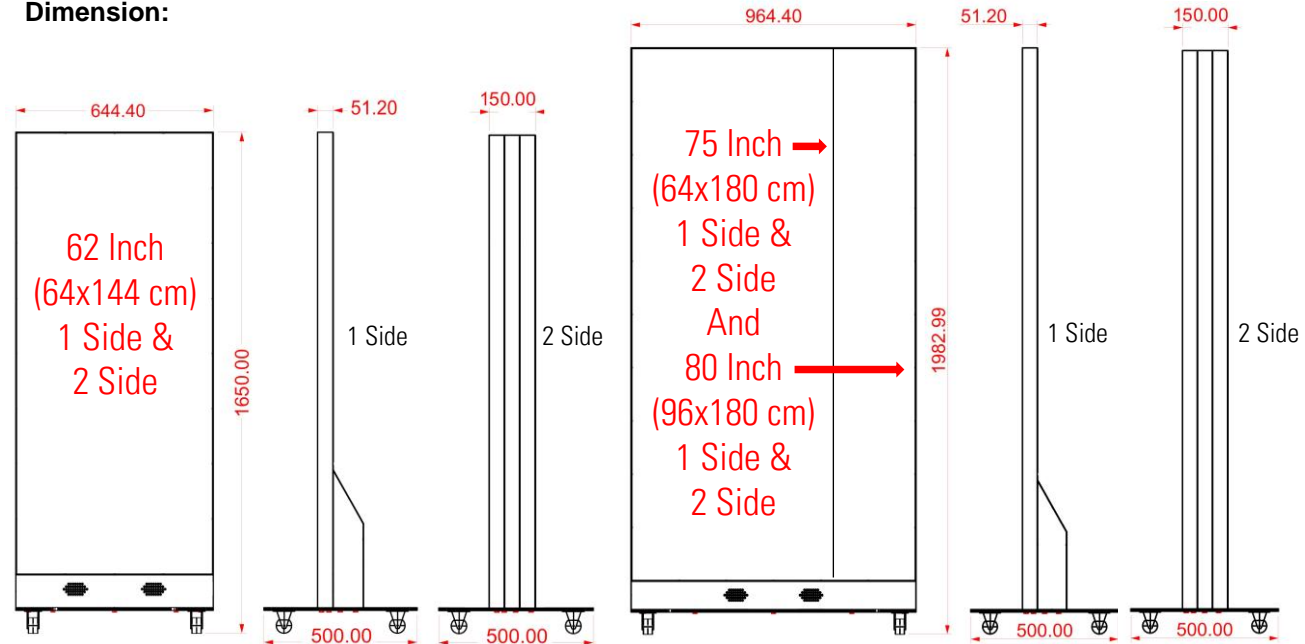

**DigiSIGN LED digital banners** designed like banners or posters with LED modules and frames capable of displaying promotions, information or highlight the event well.

- Available in 62", 75", 80" (1 and 2 side or custom)
- Choices of Pixel pitch P1.8 or P2.5
- Update content with digiSIGN Play, USB, Web or Internet
- Control via Smart Phone / Tablet.
- Full View
- Narrow bezel

**Specification:**

- Iron frame finished with powder coating
- Power Consumption 272 Watt Until 1020 Watt
- Controller : PCON 200 Pro (2K)

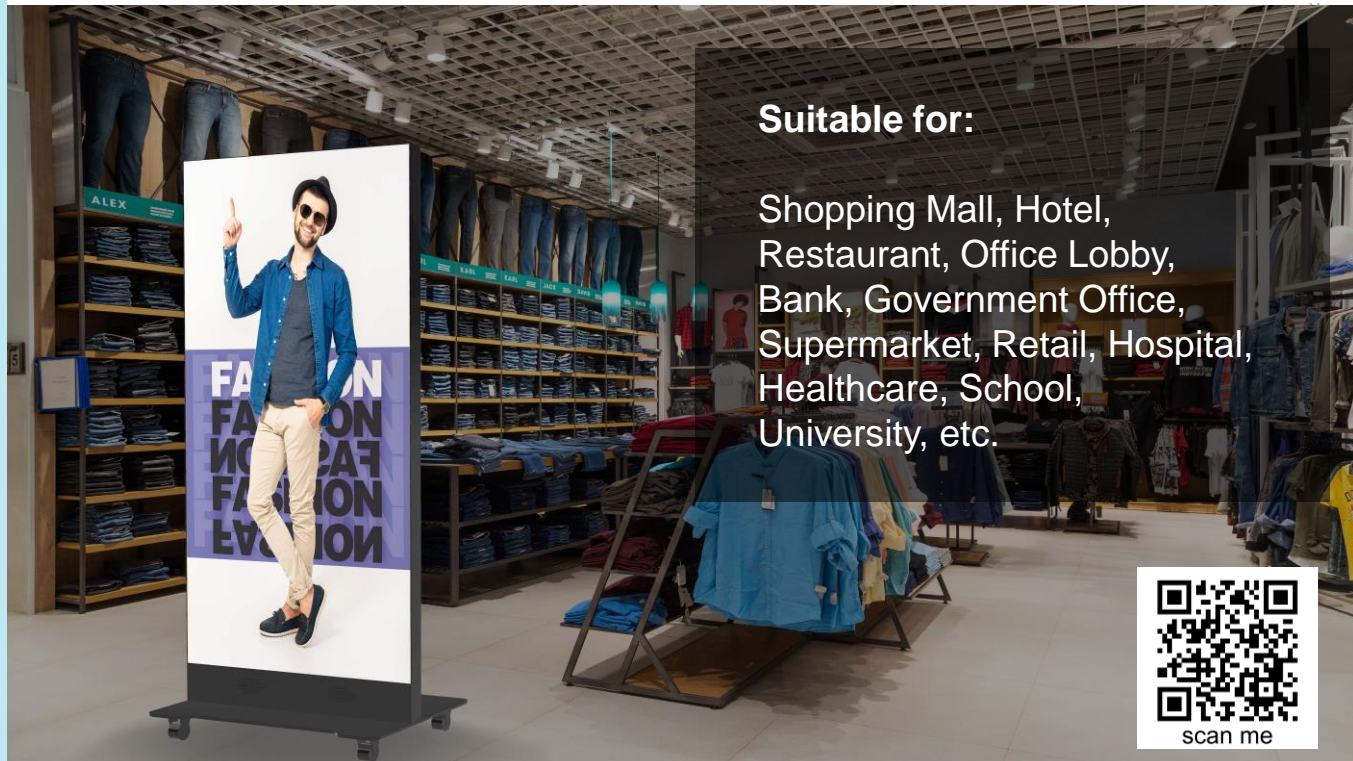

**Suitable for:**

Shopping Mall, Hotel, Restaurant, Office Lobby, Bank, Government Office, Supermarket, Retail, Hospital, Healthcare, School, University, etc.



scan me



DigiSIGN LED digital banners outdoor are specially designed and strong to be placed in extreme areas but still able to display your advertising.

Dimension:

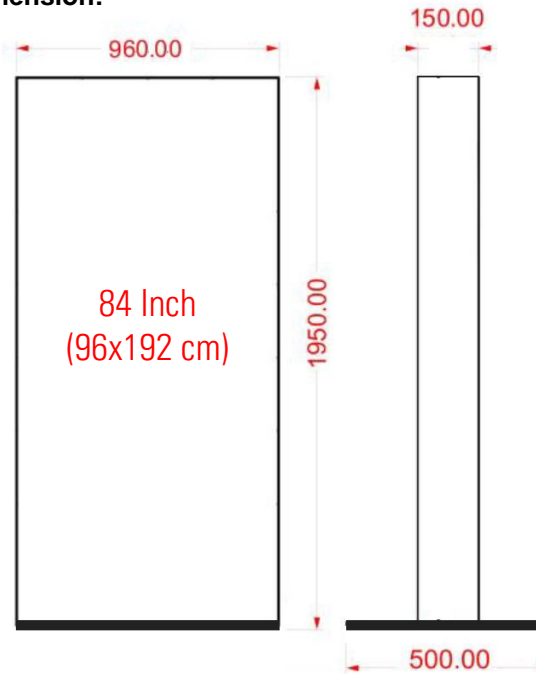

- Available 84 Inch
- Choices of Pixel pitch P4.0
- Update content with digiSIGN Play.
- Control via Smart Phone / Tablet.
- Full View & Narrow bezel.
- Controller : Novastar, Colorlight, Huidu



Suitable for:

Outdoor Shopping area, Outdoor Parking area, Office Lobby, Totem for Bank, Hospital, school area, Government Office outdoor, etc.



**Suitable for:**

Shopping Mall, Hotel, Restaurant, Office Lobby, Bank, Government Office, Supermarket, Retail, Hospital, Healthcare, School, University, etc.

DigiSIGN Slim Floorstand able to display promotions and event highlights information. A very contemporary and sleek appearance, high screen brightness makes various promotional materials and information even more attractive to visitors.

- Available Size 43 and 55 Inch in interactive touch and dynamic (non interactive)
- Super slim design
- Content can be easily changed update content with Digsign Play
- Cover with tempered glass
- Color black (Other Color or size on request)
- Wheel

**Specification:**

- Android 11 RK3568
- 350 Nits Brightness
- Network : Wifi, LAN
- 10 Points touch for interactive
- Resolution 1080 x 1920
- Lifetime 50000 Hours

**Dimension:**

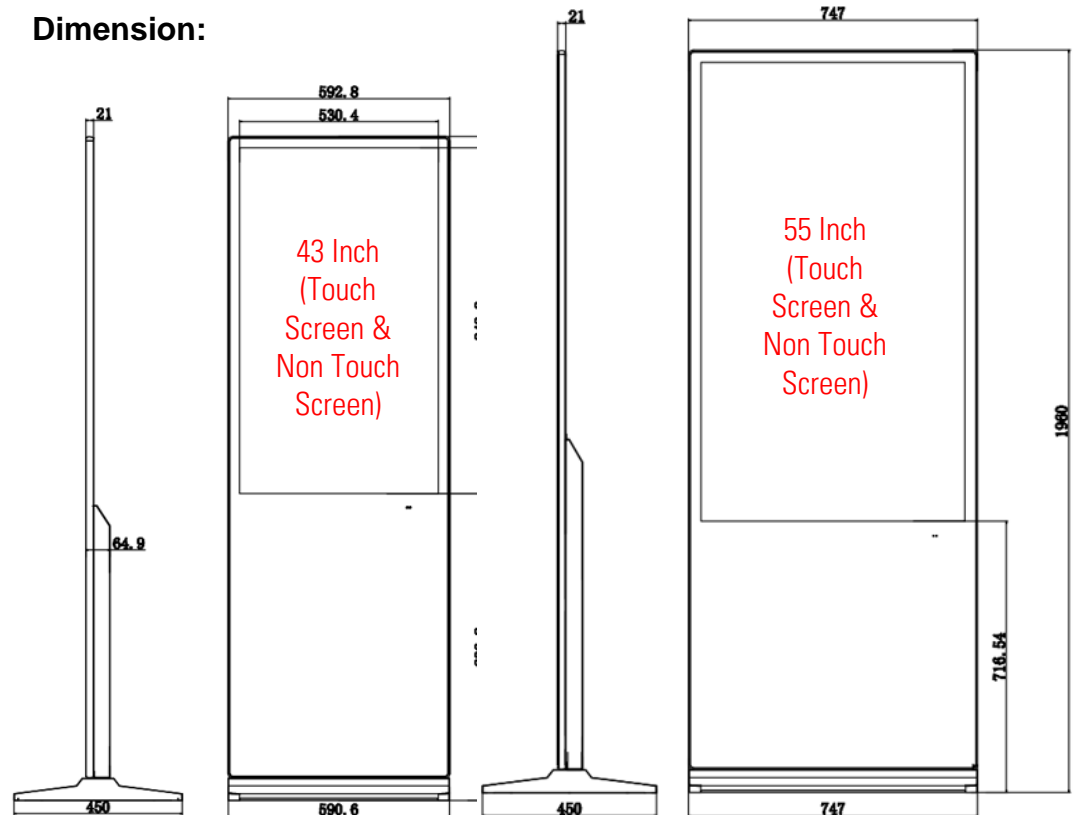



## Dimension:

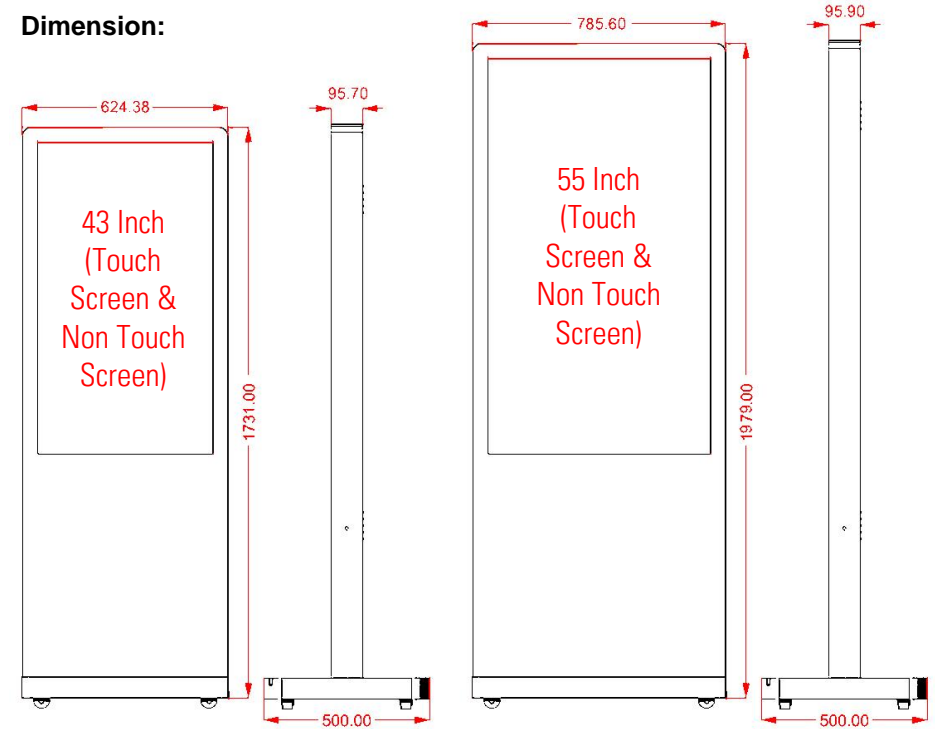

**DigiSIGN Floorstand** Designed for centralized public spaces remote content updates via the Internet, including Cloud CMS. Touch screens provide more interaction for visitors to find products/services offered in the content.

- Available Size 43 and 55 Inch in interactive touch and non touch
- Full Metal Body Fabrication
- Tempered Glass for non touch
- Commercial Grade with 24/7 use
- Update content with digiSIGN Play
- Color black (Other Color or size on request)

### Specification:

- 10 point IR Touch Overlay for Interactive
- 350-500 Nits Brightness
- Resolution 3840 x 2160
- Network : Wifi, LAN
- Power 100 - 143 W

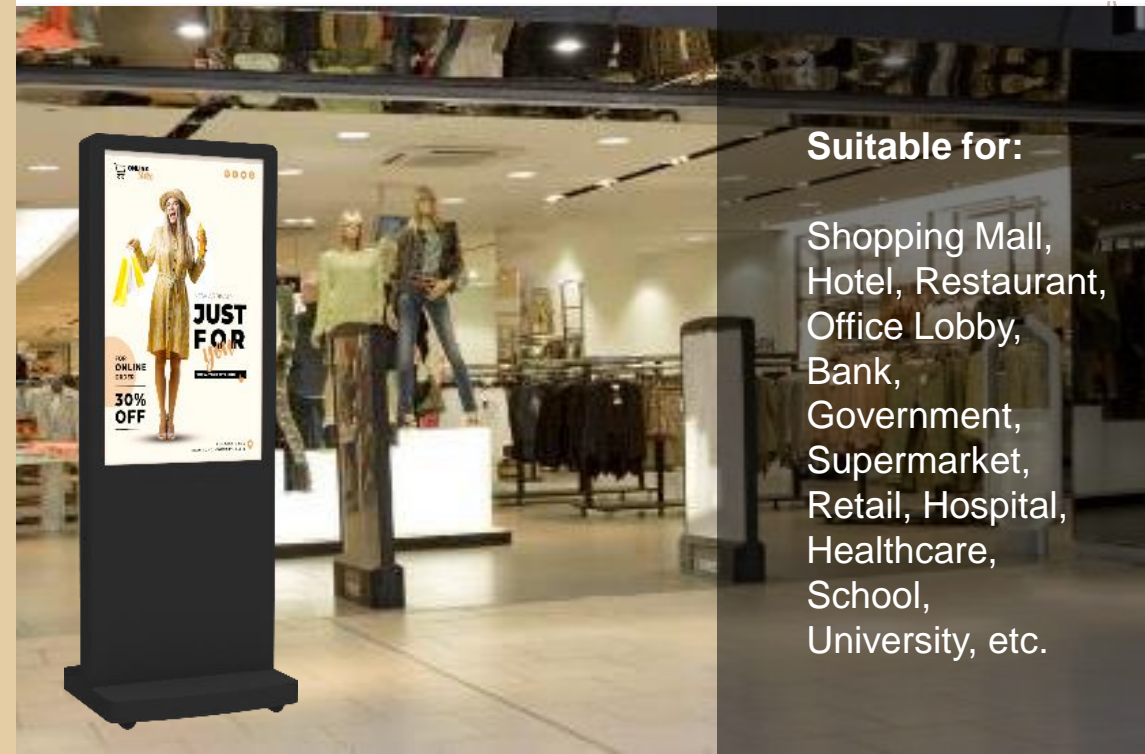

### Suitable for:

Shopping Mall,  
Hotel, Restaurant,  
Office Lobby,  
Bank,  
Government,  
Supermarket,  
Retail, Hospital,  
Healthcare,  
School,  
University, etc.



A series of LCD displays to be placed in various locations with the ease of CMS cloud update, making promotions and information right on target and attracting visitors' attention.

**Can be placed in:**

- retail shelves between products, window displays
- cashier or teller
- among the line of cosmetic, pharmaceutical products

Consists of various shapes and screen sizes ranging From 8 inches to 21.5 inches, both landscape (Horizontal) and Portrait (Vertical) positions.

**Suitable for:**

Restaurant, Hotel, Office Lobby, Shopping Mall, Bank, Government Office, Supermarket, Retail, Hospital, Healthcare, etc.

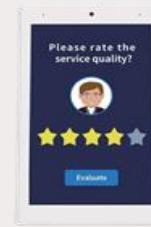

**Desktop Digital Signage 10P**

- 10 inch capacitive touchscreen
- 160x255x114mm / 0.72 kgs

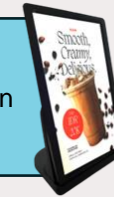

**Desktop Digital Signage 14P**

- 14 inch capacitive touchscreen
- 335x209x25mm / 1.34 kg

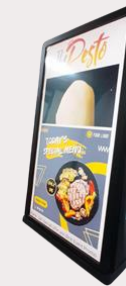

**Desktop Digital Signage 21P**

- 21 inch capacitive touchscreen
- 308x510x35mm / 3,5 kg



**Desktop Digital Signage 10L-Double**

- 10,1 inch capacitive touchscreen
- 240x132x163mm / 1.29 kg



**Desktop Digital Signage 10L-LB**

- 10 inch capacitive touchscreen
- 250x180x10,9mm / 0,8 kg

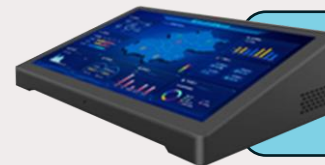

**Desktop Digital Signage Tablet 10L**

- 10 inch capacitive touchscreen
- 258x63x177mm / 0.9kg

**General Specification:**

Operating system Android 11/Quad core cortex A17  
 Brightness 250 nits Brightness  
 Storage 2GB RAM, 16 GB Storage  
 Connectivity Wifi 802.11 + LAN, USB  
 CMS Digisign Play CMS & Player



scan me

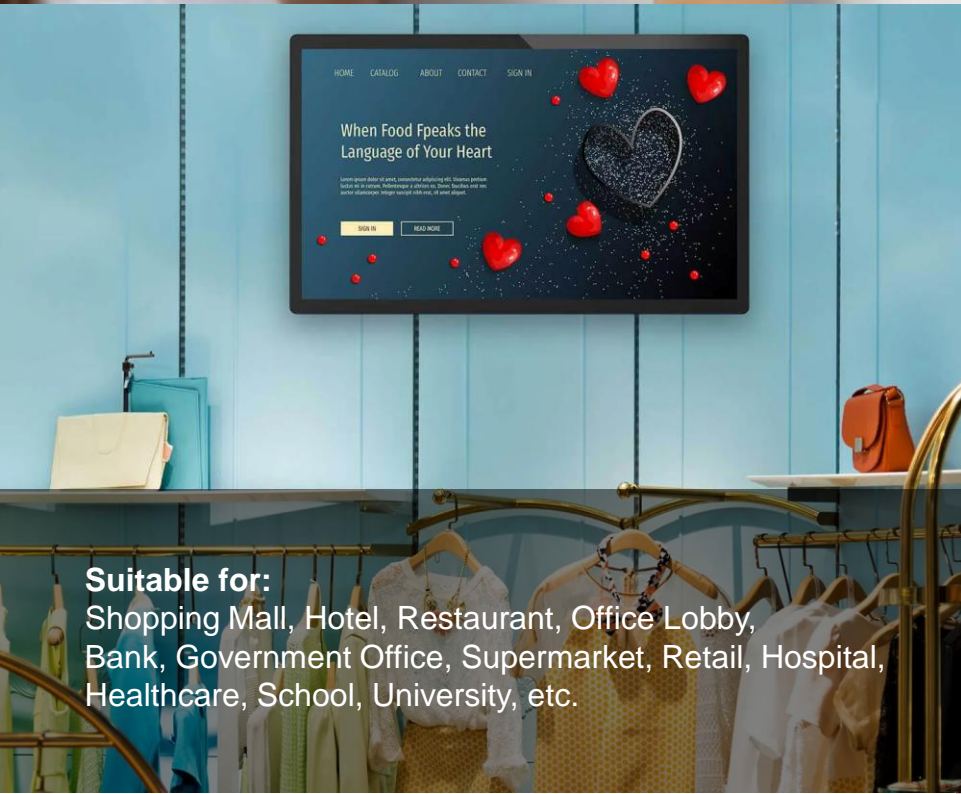
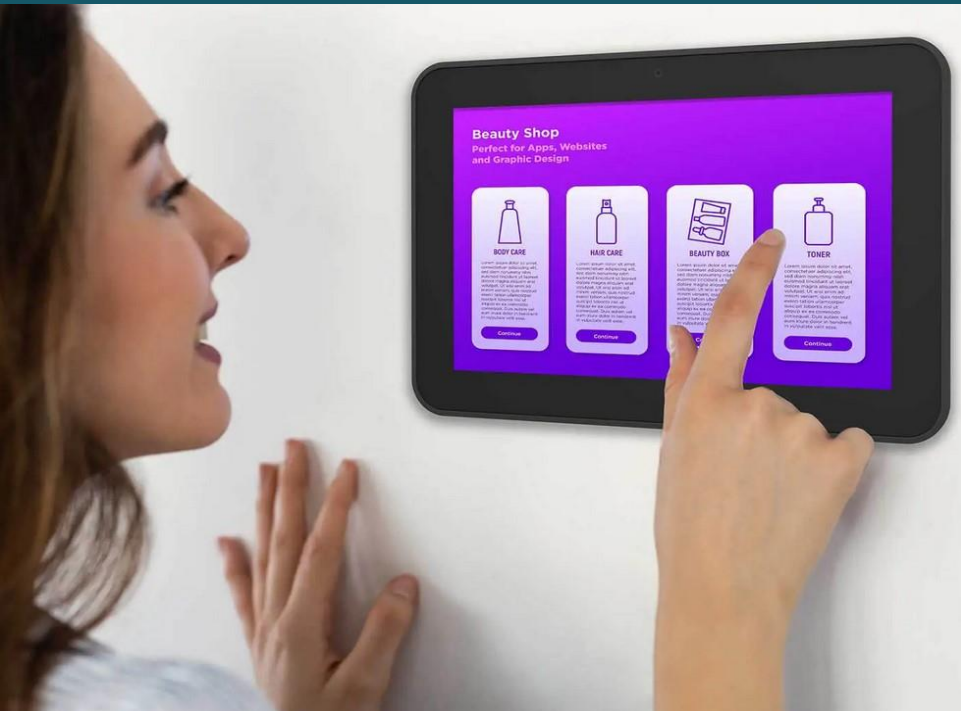

**Suitable for:**  
 Shopping Mall, Hotel, Restaurant, Office Lobby,  
 Bank, Government Office, Supermarket, Retail, Hospital,  
 Healthcare, School, University, etc.

## Philips Touchscreen 10 Inch

10 inch 5 points touchscreen

Desktop Stand Available

261(W) x 167.2(H) x 29(D)/0.71 kgs

## Digital Signage 14 inch

14 inch Capacitive touchscreen

Desktop Stand Available

335 x 209 x 25 mm / 1.34 kg

## Digital Signage 215P

22" inch Capacitive touchscreen

Desktop Stand Available

512.8\*308.9\*33.5mm / 3.76 kg

### Philips Specification

- Operating system android 8,1 - Color black - Brightness 300 cd/M2
- Storage 2GB RAM, 16 GB Storage - Resolution 800 x 1280 pixel
- CMS Digisign Play CMS & Player

### General Specification

- Operating system android 11/RK3568 - Brightness 250 nits Brightness
- Color Black - Storage 2GB RAM, 16 GB Storage - Resolution 800 x 1280 pixel
- Connectivity wifi 802.11 + LAN, USB-C - CMS Digisign Play CMS & Player



## Dimension:

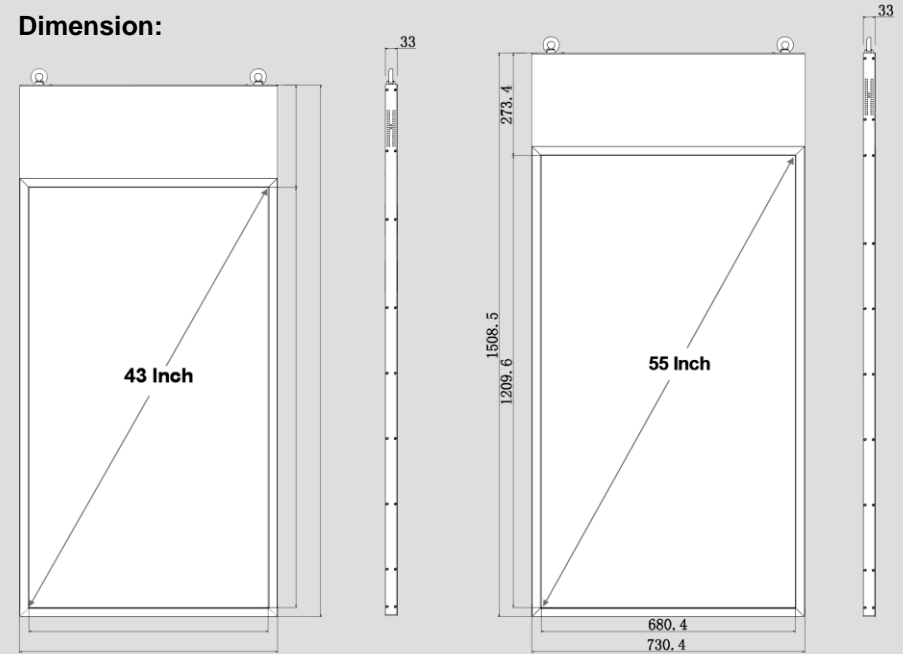

**DigiSIGN Dual Side Hanging LCD** comes in two sizes, 43 and 55 inch, with a nice sleek white enclosure and incredibly slim profile of less than 35 mm. The screen also comes with an included ceiling mount to easily install in the store.

### Key Features:

- Super slim design 33 mm depth
- Unique content for each side
- Higher brightness for window facing side
- Integrated ceiling mount with cable management system

### Specification:

- Android 11 RK3568
- RAM 2 GB/16 GB
- 1080 x 1920 Full HD Resolution
- 450cd/m<sup>2</sup> (for indoor side) and
- 700nits (for indoor window side, can not have direct sunlight)



### Suitable for:

Front area of shopping mall, Tenant in shopping mall, Bank, Retail store, Food & Beverage restaurant, Fashion store, etc.



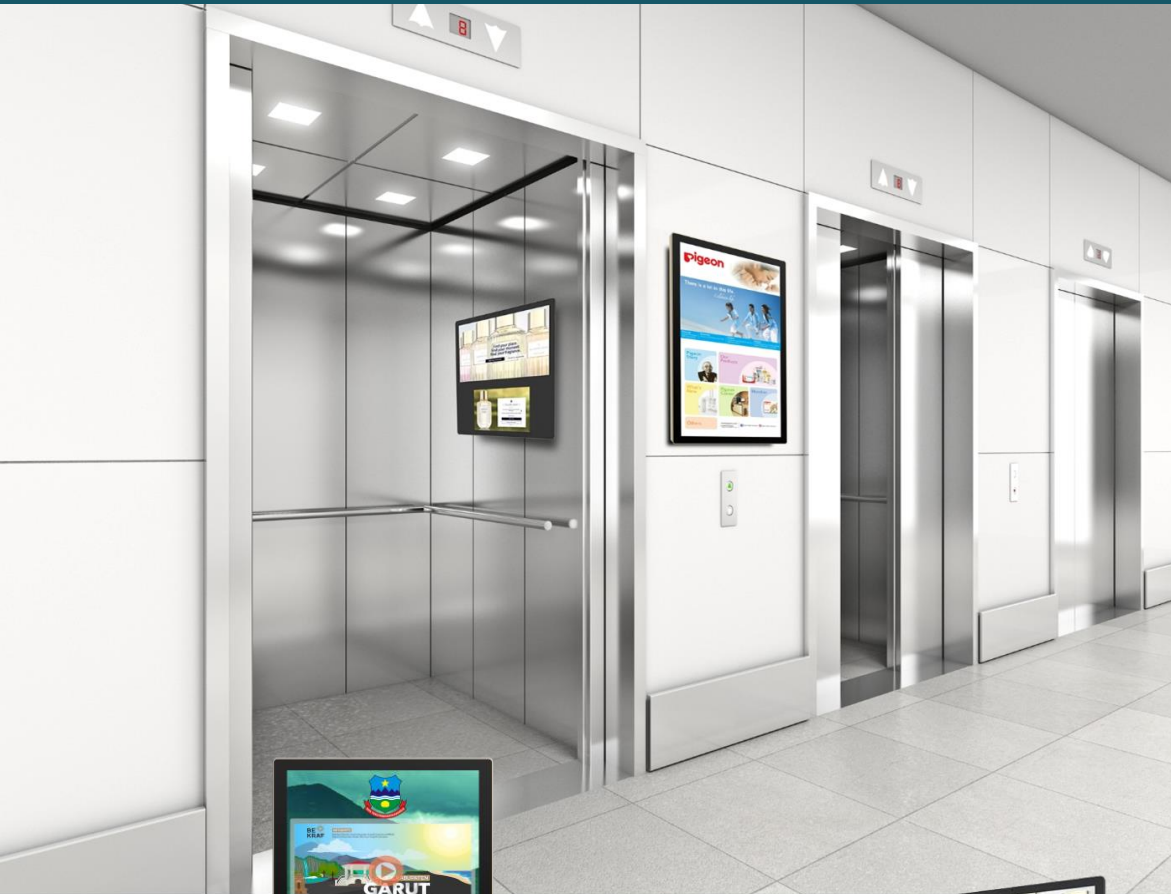

**Lift media display** with a special design for lifts, With an attractive digital display, audiences can easily see advertisements displayed while in the lift or waiting for the lift.

- Slim & Rounded corner design
- with a strong screen
- Easy Installation
- Content can be easily changed
- Update content with digiSIGN Play

Available in 22 - 32 inch and 15.6 - 10.1 inch on 2 front screens. With Tempered Glass, Wifi Network.

**Suitable for:**

Lift Shopping Mall, Lift Hotel, Lift Restaurant, Lift Office, Lift Bank, Lift Government Office, Lift Hospital, Lift School or University, etc.

**Note How to install a display inside an lift:**

- No need to make holes in the lift wall, just use special 3M double-sided VHB tape.
- Electrical connection from inside the lift to the monitor is required

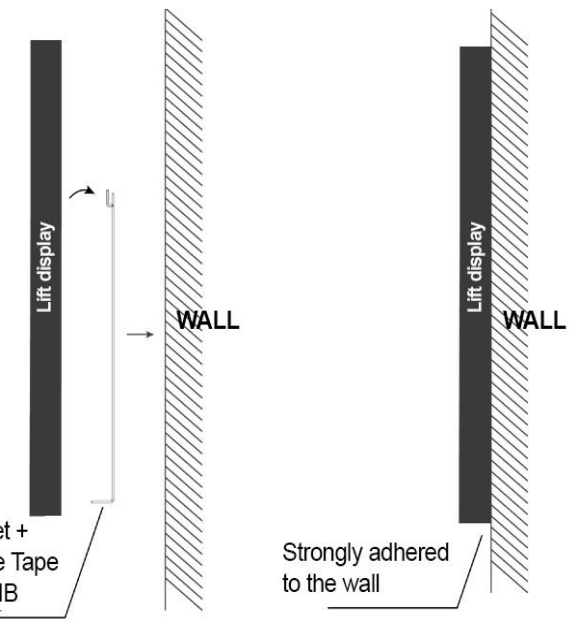

Specification	32 Inch Portrait	22 Inch Portrait	15.6 Inch + 10.1 inch Dual Screen Landscape
Diagonal Size	32 inch	22 inch	15.6 inch & 10.1 inch
Brightness	400 cd/m2	250 cd/m2	250cd/m2
Active Display Area	697.4 (H) x 391.4 (V) mm	475 (H) x 266.4 (V) mm	(343 x 192 mm) + (216 x 135 mm)
Resolution	1920 x 1080	1920 x 1080	1920 x 1080



**Professional displays** With interactive displays, presented to Simplify business processes, as well as communicate marketing messages, information or Promotions to customers.

### Key Features

- Industrial / Commercial
- 350 – 700 Nits
- System on Chip, with Digital Signage Features
- UHD / HD-4K
- Auto Power On-off, Timer Scheduling

### Specification:

- Brightness Indoor: 350/450/500/700 nits.
- Brightness Outdoor/semi outdoor with 1000/1500/2500 Nits
- Bazel: 6.9(Top)/6.9(Side)/8.9(Bottom) mm
- High durability for long hour usage 24/7
- Typical Size 22, 32, 43, 49/50, 55, 65, 75, 86 and 98 Inch
- Has a digital signage processor
  - Samsung – Tyzen, LG-Web OS, Android.
- Usage suggestions : 12/16/24 Hour/Day.
- Brand : Samsung, LG, Hisense, Goodview.



### Menu System



Portrait usage



Landscape usage

### Suitable for:

Retail Store, Factory, Hotel, Hospital, Food resto. Shopping Mall, Office Lobby, Financial Service, Government Office etc.

**\*Support by DigiSIGN Play for all brand**

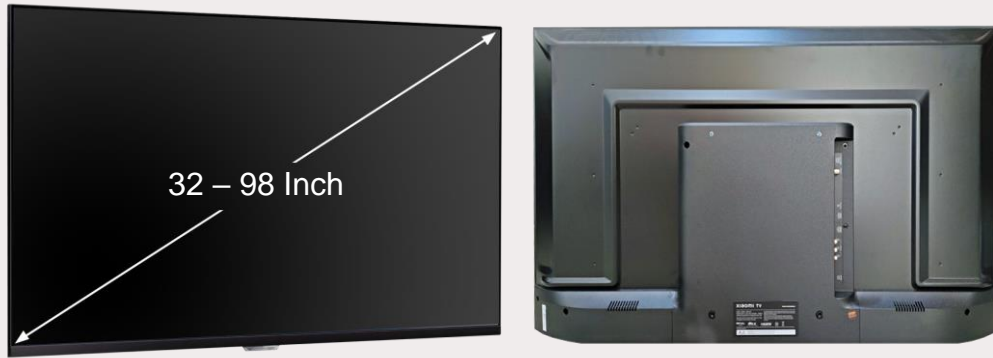

## Digital Media Player box (Android)



Turn your Smart TV / Home TV into a Digital Signage Display with only add a Digital Media Player box (Android)

**Consumer TV** for your product promotion needs, at low and economical costs. but does not eliminate the main function.

### Key Features

- Economic / Affordable price ( Less <50% Proprice )
- Design for home / Low usage 6-12 hours
- Enhance to DS feature by digisign box

### Specification:

- Typical Size 32, Up to 98 Inch
- Brightness Indoor: 350 - 300 nits.
- Bazel varies
- Many brand choices  
( Example: Samsung, LG, Hisense, Xiaomi, TCL etc.)

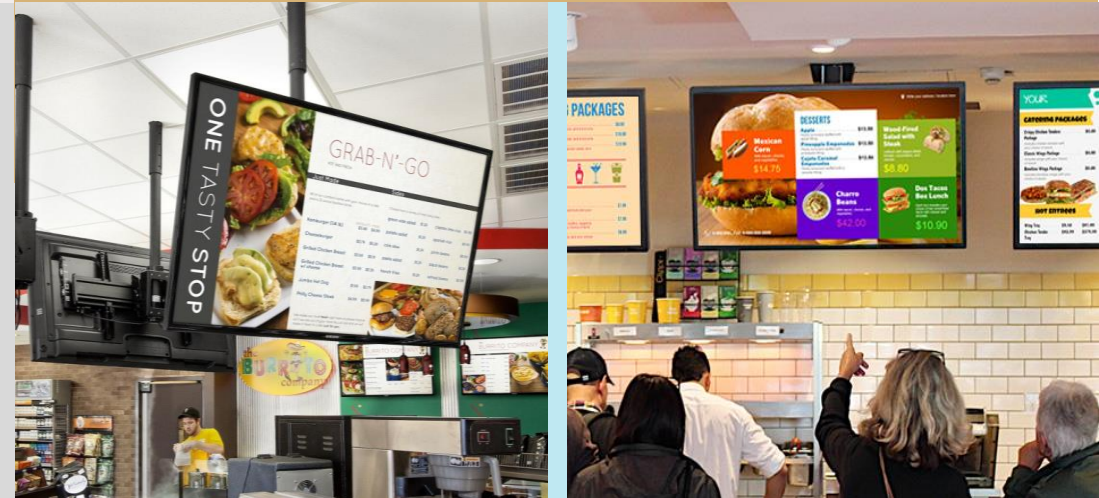

### Suitable for:

Factory, Hotel, Hospital, Coffee shop.  
Retail Store, Shopping Mall, Restaurant, Office Lobby,  
Financial Service, Government Office etc.

**\*Support by DigiSIGN Play for all brand**



Turn your Smart TV / Home TV into a Digital Signage Display with only add a Digital Media Player box (Android)



### Features

- Operating system: Android 11
- CPU: RK3566, Quad-core. GPU: Mali-G52
- RAM: DDR3, default 2GB (optional 4GB)
- Internal memory: eMMC 16GB (32 GB)
- Connection Support RJ45 100M Ethernet port and Ethernet.
- Power adaptor DC12V 1.5A
- Video Support H.265, VP8, MAV, WMV, AVS, H.263, MPEG4 and other video formats 1080P multi-video decoding
- Image support various picture formats such as JPG, BMP, PNG



### Digisign play CMS implementation on digital display

Feature	TV HDMI with USB	TV android / android box low cost	TV with digital signage android box	Professional display
Timer ON/Off	X	X	✓	✓
Screen Rotation	X	X	✓	✓
Content transition	X	✓	✓	✓
Auto start apps	X	✓	✓	✓
Remote desktop	X	✓	✓	✓
Device monitoring	X	✓	✓	✓



**Infosigns or digital menu** are designed to help attract customers and make it easier for customers to get information, potentially leading to increased sales.

- 21,5 Inch capacitive touch
- Attractive design & modern
- Easily update your menu in real-time
- Iron frame finished with powder coating

**Specification:**

- Android 11 RK3568
- 250 Nits Brightness
- Network : Wifi, LAN
- Speaker: 5W\*2
- 10-Point capacitive touch
- Resolution 1920x1080
- Power Consumption 25W
- Ram/Memory : 2/16GB



**Suitable for:**

Restaurant, Office Lobby, Bank, Government Office, Supermarket, Retail, Shopping Mall, Hotel, Hospital, Healthcare, School, University.

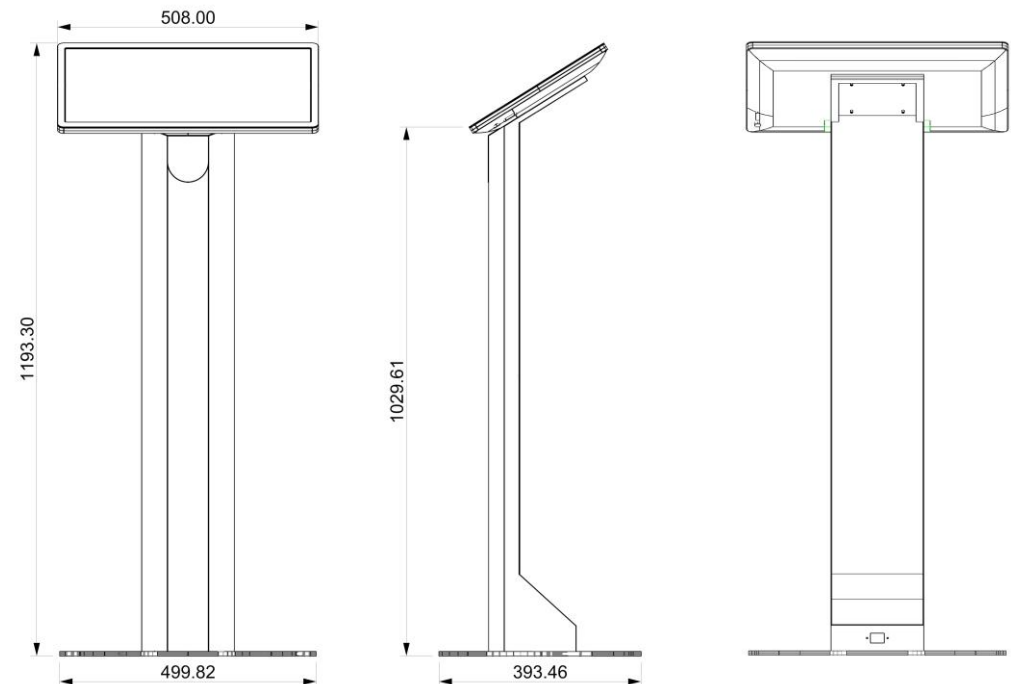



### Suitable for:

Home, Gym, Restaurant, Office Lobby, Supermarket, Shopping Mall, Hotel, Hospital, Healthcare, etc.



**Portable smart touch display** Smart screen display is a Portable smart device capable of displaying interactive content And easily moved according to your needs

- 24 and 32 Inch touch screen
- Attractive design & modern
- Easily update your content & play.
- Equipped with an internal battery and a sturdy stand
- Camera (Optional)

### Specification:

- Android 12
- 250 Nits Brightness
- Network : Wifi, LAN Bluetooth
- Ram/Memory : 8GB/128GB
- 10-Point capacitive touch
- Resolution 1920x1080
- Speaker: 5W\*2
- Battery capacity 5200/7500mAh

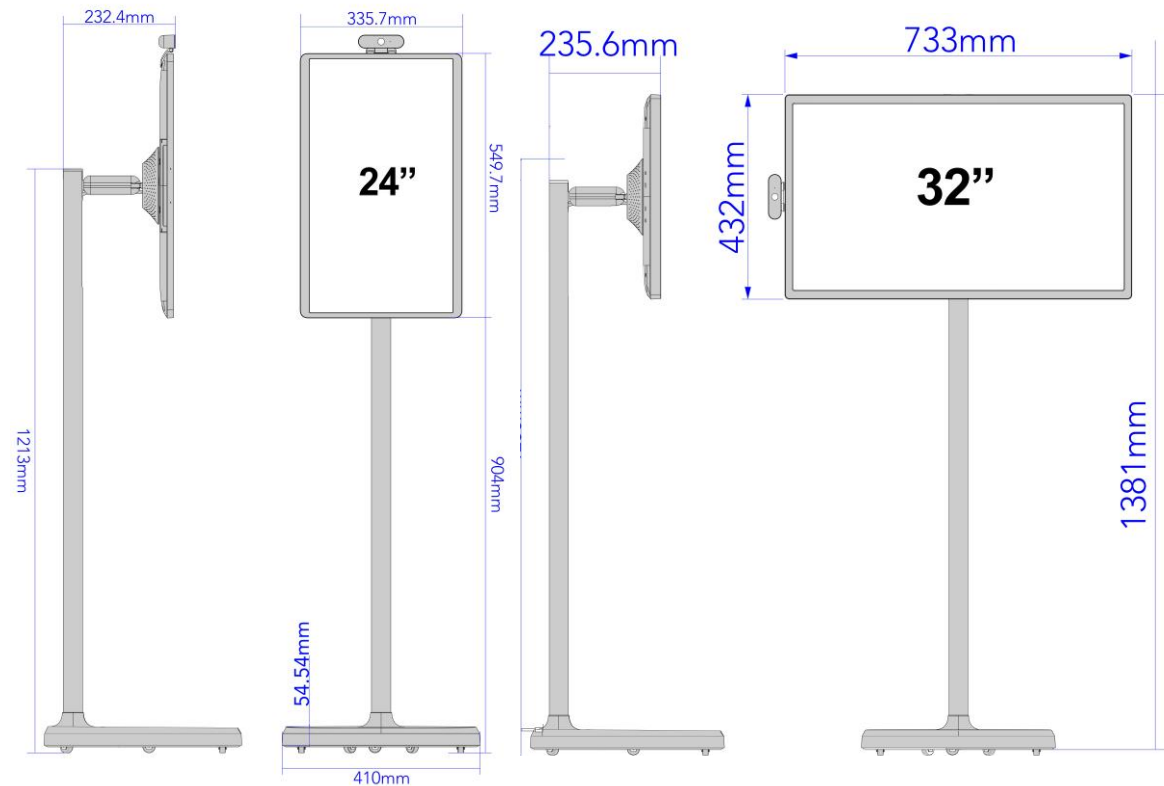



# **The LED Videotron options from InnoGRAPH**



A videotron is one of the most effective visual communication tools in this digital era, providing the ability to display engaging and relevant content to a wide audience.

- LED Module with a magnetic system
- Attractive, bright and bright screen display.
- Easy use, reliable, durable, not easily damaged and faded
- Availability of after sales services and factory support



**320 x 360 mm** LED Module  
Back side covered  
P1.8 & P2.5



**All in One Module**  
Module, PCB, Receiving Card,  
Power Supply, IC.  
In One Body

## Selection of 16:9 true ratio from 116 inch up to 318 inch

	32	64	96	128	160	192	224	256	288	320	352	384	416	448	480	512	544	576	608	640	672	704			
36	1	2	3	4	5	6	7	8	9	10	11	12	13	14	15	16	17	18	19	20	21	22			
72	2																								
108	3																								
144	4			256 x 144 cm				116"																	
180	5			320 x 180 cm					145"																
216	6			384 x 216 cm						173"															
252	7							448 x 252 cm			202"														
288	8									512 x 288 cm			231"												
324	9										576 x 324 cm				260"										
360	10											608 x 360 cm					289"								
396	11															704 x 396 cm				318					

### Product Parameter:

Model Videotron	Videotron P1,8	Pvideotron P2,5
Pixel Pitch	1,8	2,5
Module Resolutions	171*192	128*144
Module Weight	1,16 kg	
Cabinet Size	320*360*39	
Brightness (cd/m2)	500 nits	600 nits
Power Consumption	295 watt	
Refresh rate (Hz)	3840 hz	
Viewing Angle ( H/V °)	117°/H 170°/V	
Maintenance Methods	Front	
Controller	PCON 200 Pro (2K)	







A videotron in a retail store can attract customers attention by dynamically displaying the latest promotions, special offers, and product information in an engaging way.



**Suitable for:**  
Restaurant, Supermarket, Coffee store, Clothing store, etc

## Retail application scenario:

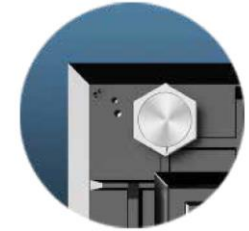

Magnetic Front - Installation

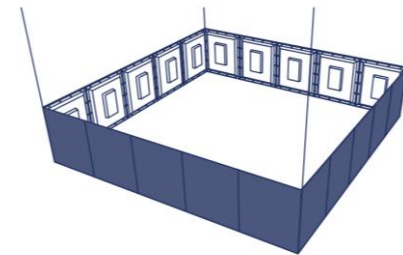

Hanging

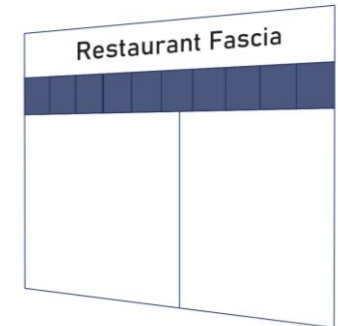

Store Fascia

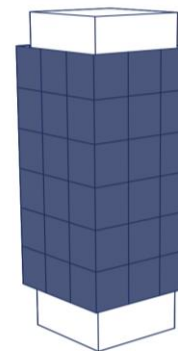

Pillar



Desk

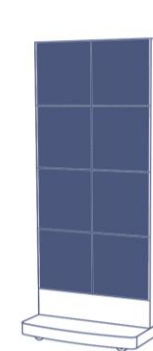

Floorstand

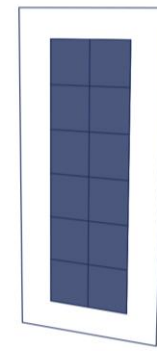

Vertical Banner



scan me



**LED Videotrons** can be used to convey information such as event schedules, announcements, and other important information. Digital screens can be strategically placed to ensure everyone can see them

- Attractive, bright and bright screen display.
- Easy use, reliable, durable, not easily damaged and faded
- Availability of after sales services and factory support
- Frame construction using hollow galvanized steel



**4K Integrated Bar**  
4K Controller + Soundbar Speaker

## Configuration :

**Wall Mounted 116 inch up to 318 inch**



**With Stand 116 & 145 inch**





A videotron in a place of worship can be used to display announcements, event schedules, song lyrics, and sermons clearly and engagingly for the congregation.



Installation simulation:



Cinema



University



Office Lobby



Office

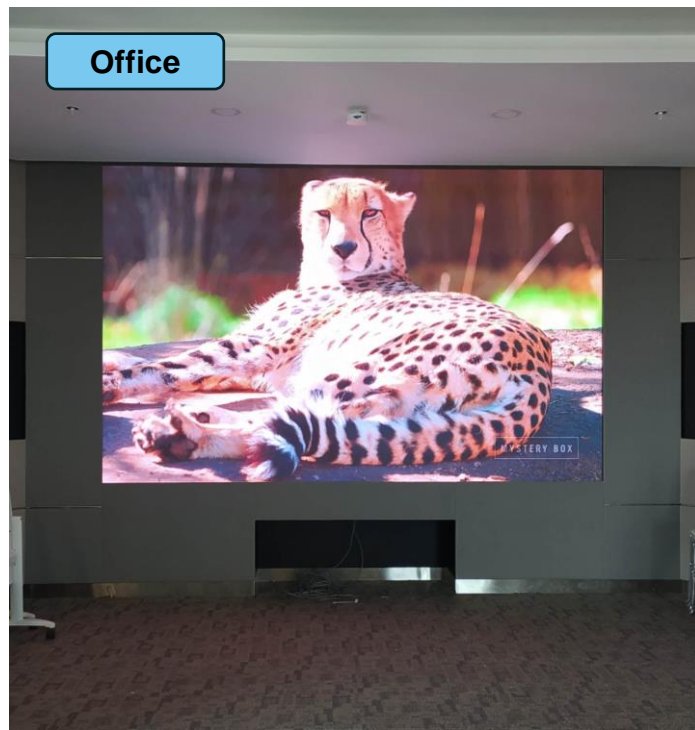

Bank

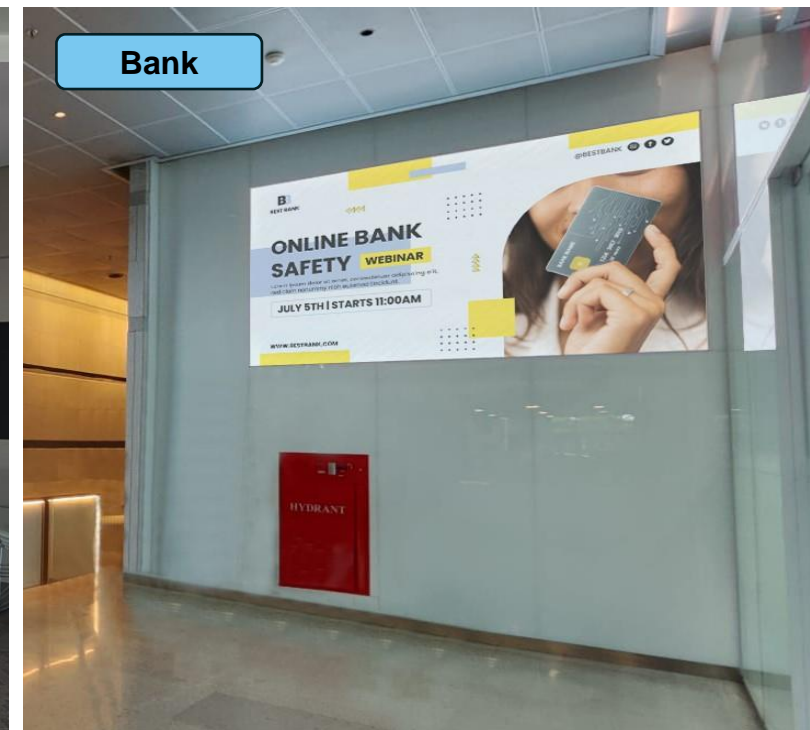

## Die-cast Aluminium Cabinet



### Features

- Has international module market standards
- Cost-effective outdoor videotron.
- Fulfill customer demand for cabinets.
- Avoid installing complicated steel structures.

### Specification:

- Pixel Pitch (mm)  
2.5 | 3.076 | 4 | 5 | 5.926 | 8 | 10
- Brightness (nit)  
5000 | 5000 | 5000 | 5000 | 5000 | 4500 | 5500 | 6000 | 7000
- High contrast of 3000:1  
Vivid color, delightful visual experience
- High Refresh rate 3840HZ.
- Size :960\*960mm\*120mm
- Module Size: 320\*160mm / 192\*192mm

## Metal Plate Iron Cabinet



### Suitable for:

Advertising billboards,  
Tower board for Bank,  
Government Office,  
Shopping Mall, Hotel,  
Hospital, University.

**LED display special shape** develop your creative ideas with this product, you can make various shapes so that your product attracts attention

**Basic shape:**

- Square 32 x 36 cm
- 45° corner
- Pixel Pitch: P1,8 and P2,5

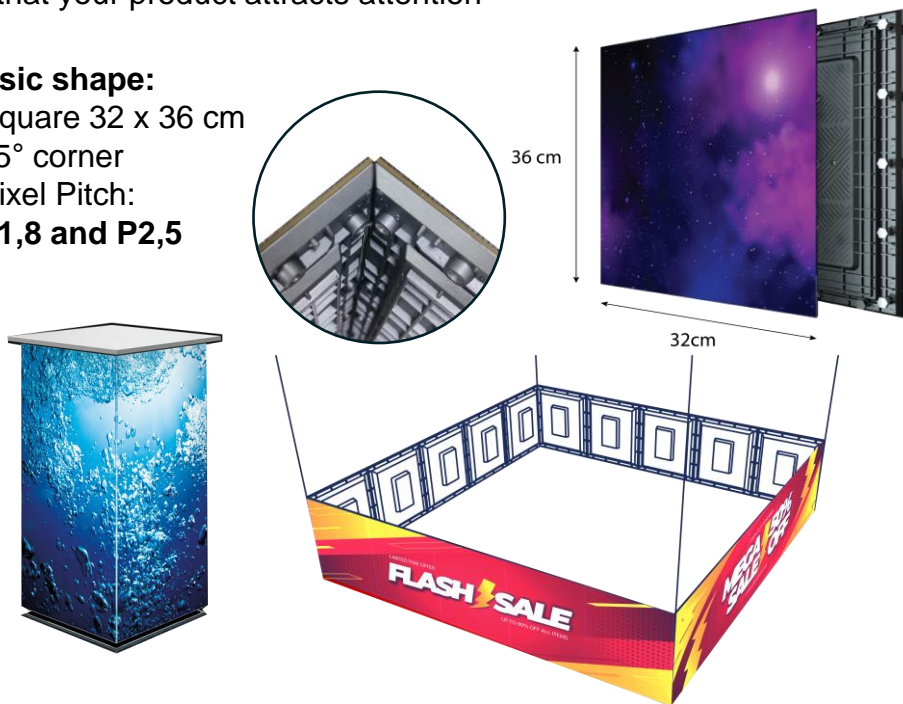

**Basic shape:**

- Flexible 16 x 32 cm
- Pixel Pitch: P1,5 and P2,6



**Case Usage:**

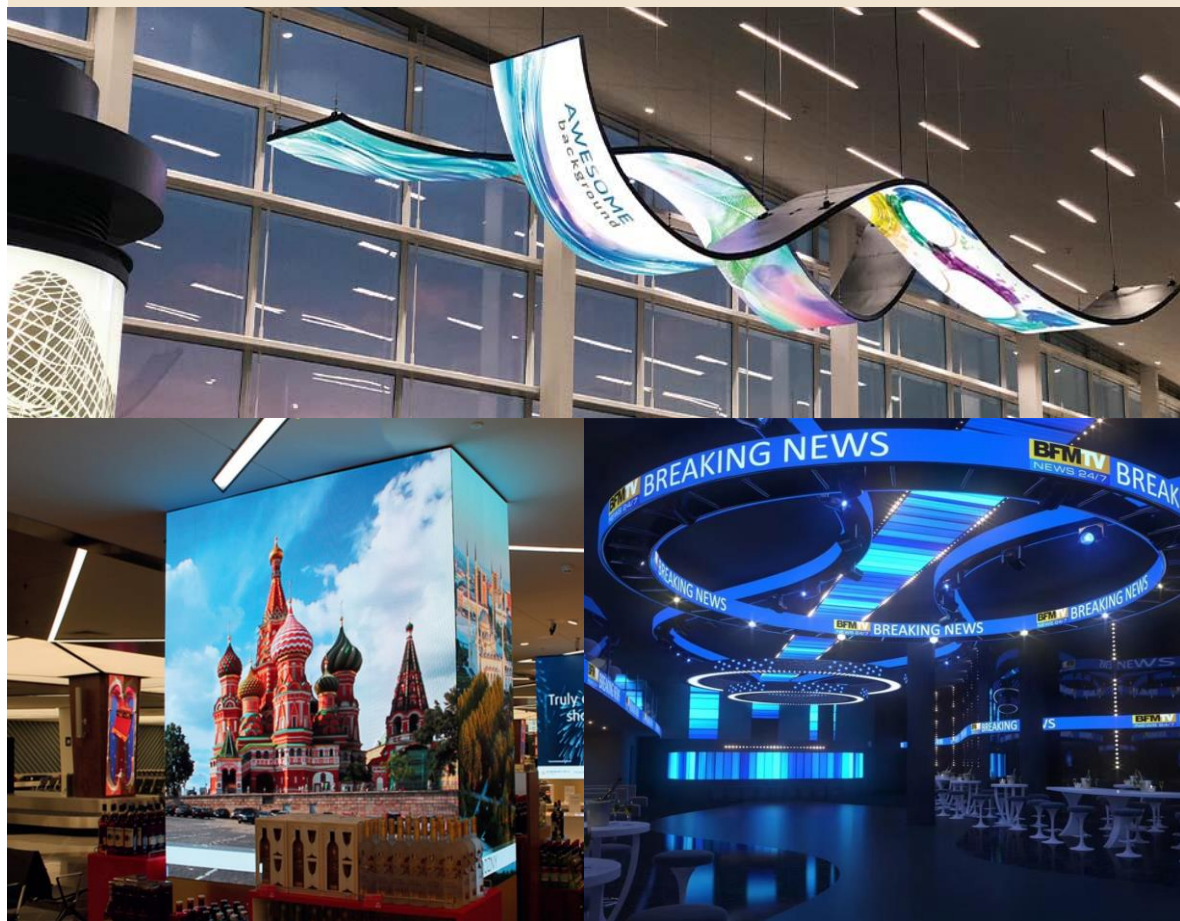

**Suitable for:**

Shopping Mall, Hotel, Restaurant, Office Lobby, Bank, Government Office, Supermarket, Retail, Hospital, Healthcare, School, University, etc.

**Common Specification:**

- LED need special bracket / mounting frame
- Digisign play ready

**Custom shape CAN**  
Pixel Pitch: P2,5



**Dimension:**



**Custom shape CUBE**  
Pixel Pitch: P2,5 / P3 / P4

**Dimension:**

- 960x960x960mm
- 640x640x640mm



**Custom shape SPHERE**  
Pixel Pitch: P2 & P5

**Diameter :**

- 1 M, 1,5 M, 2 M

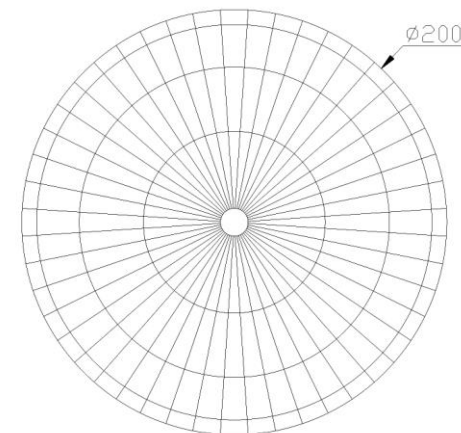
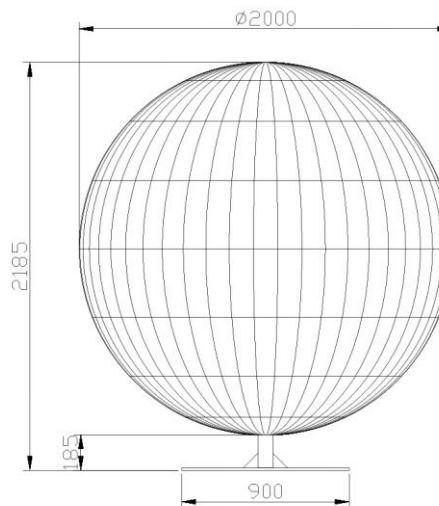

## LED cabinet module for rack header

### Type 1 : SMD & GOB P1,5 & P1,8/1,9

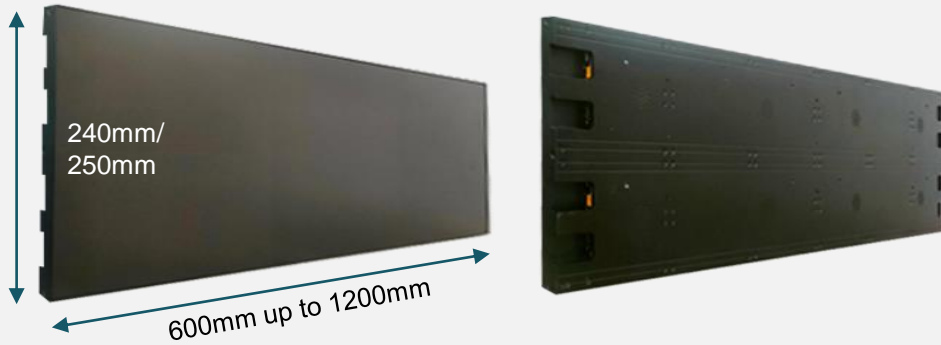

- Basic Size : 600\*240mm / 900\*240mm /1200\*240mm.  
750\*250mm / 1000\*250mm.
- Can be configured according to your needs
- Cabinet finished ready to install.

### Type 2 : SMD P1,8



- Basic Size : 320mm\*360mm\*39mm.
- Can be configuration to: 2\*320, 3\*320, 4\*320, .... 10\*320mm.
- Steel frame structure
- Total thickness: 60mm

## Case Usage:



## Suitable for:

Transportation, Shopping Mall, Restaurant, Supermarket, Retail.

## Common Specification:

- Digisign play CMS controlled
- Size configuration can be customized





**37 Inch Stretch Display** are the ideal and versatile display solution to meet virtually any need.

- Stretched resolution
- 24/7 operation
- 700nit high brightness
- Power consumption: 70W
- 4K UHD viewing experience
- Slim depth design
- OS Tizen 4.0

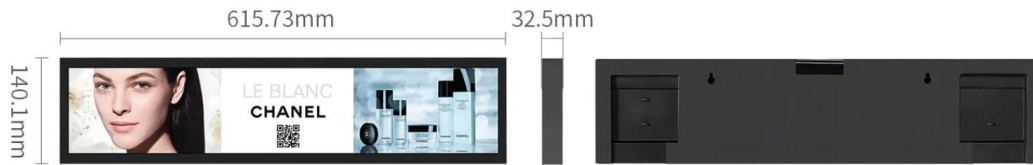

## 24 Inch Bar-type Digital Signage

Various other sizes available:  
**28"** (735,1 x 168,1 x 33mm) and **37"** (902,11 x 284,4 x 39mm),

### General specifications:

- 1920\*360 resolution
- OS Android
- Ram/memory 2/16GB
- Network: Wifi, Ethernet, Bluetooth 4,0



### Case Usage:

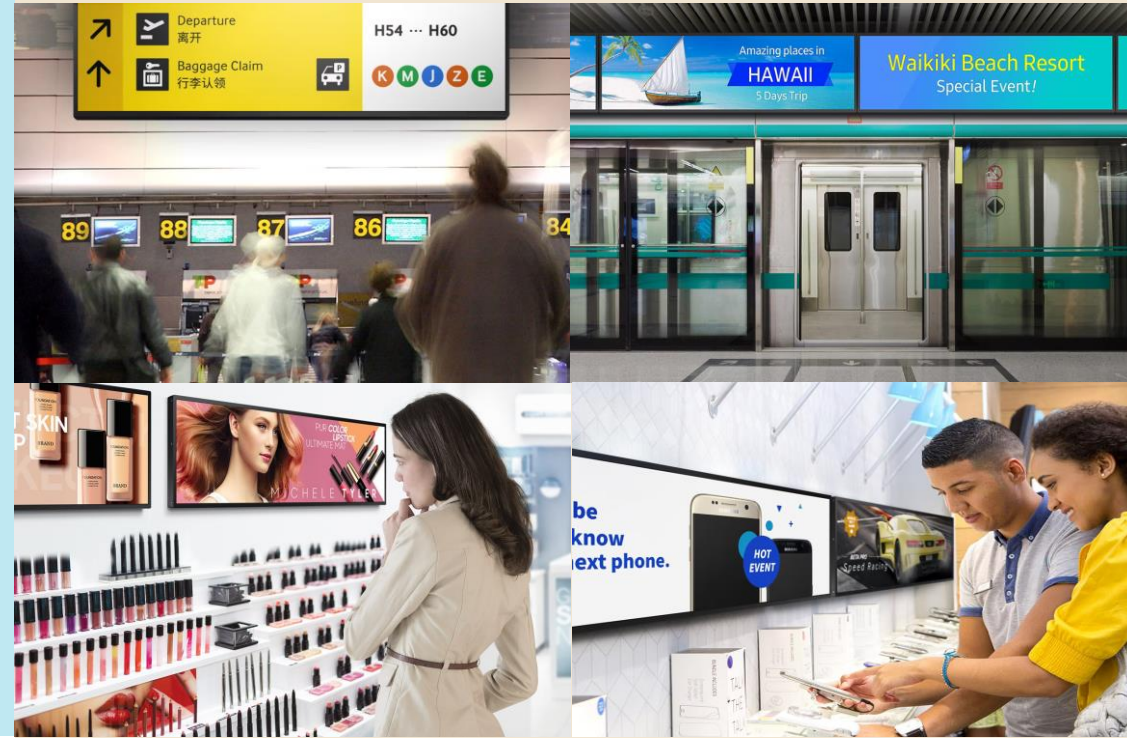

### Suitable for:

Public area, Station, Terminal, Shopping Mall, Hotel, Restaurant, Office Lobby, Government Office, Bank, Supermarket, Retail, Hospital, Healthcare, School, University, etc.



**LED Transparent** is a product that is stunning and has a tremendous influence on product information and promotions with extraordinary display effects

- Flexible, Easy installation, no need steel structure.
- Ultra thin design
- Arbitrary folding and banding
- Seamless splicing

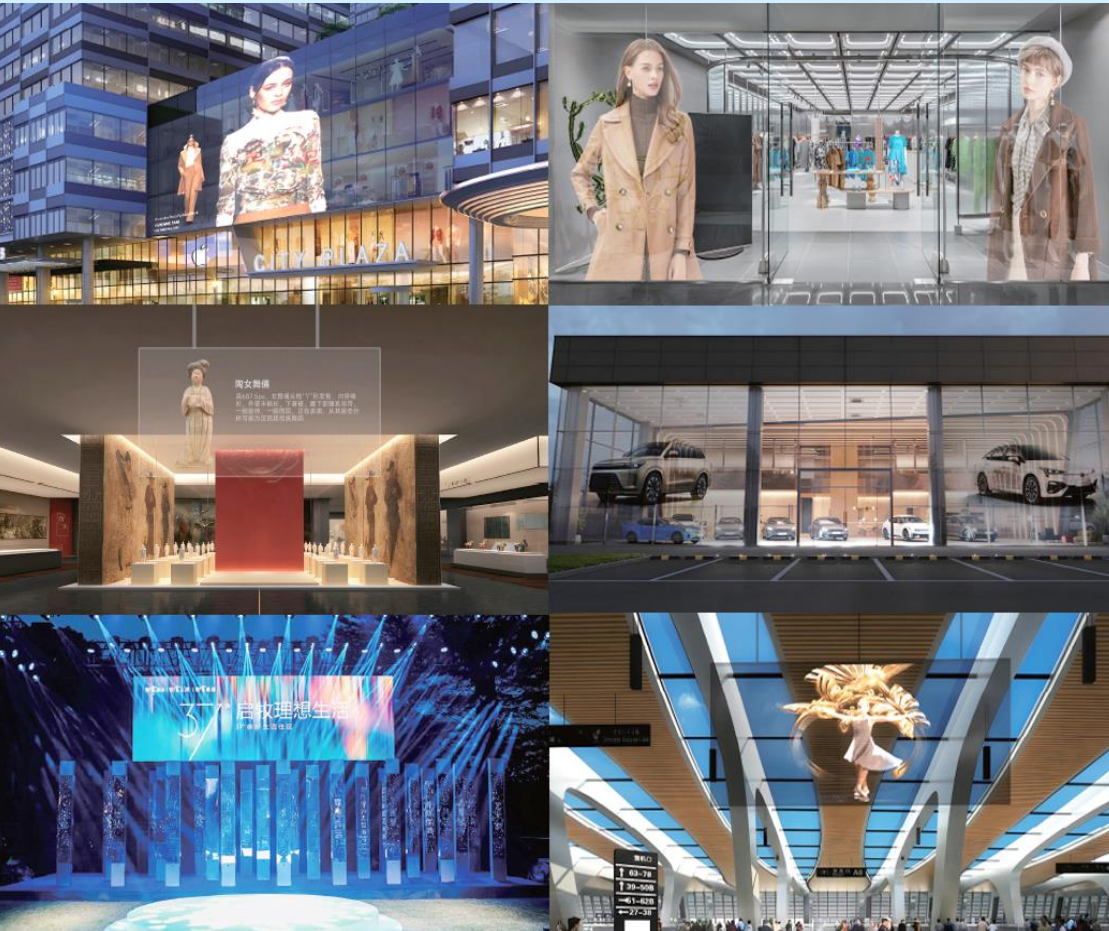

**Suitable for:**

Public area, Station, Terminal, Shopping Mall, Hotel, Restaurant, Office Lobby, Government Office, Bank, Supermarket, Retail, Hospital, Healthcare, School, University, etc.

## 1. LED CURTAIN DISPLAY



- Model T2,6 : P2.6 - 5.2
- Model T2.8 : P2,84 - 5,62
- Model T3.9 : P3,91 - 7,82
- Model T10 : P10,42
- Model T15 : P15.63

## 2. LED CRYSTAL FILM SCREEN

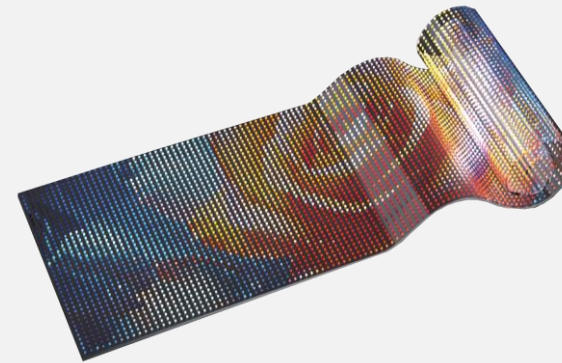

- Size Mode 40 x 100 cm  
**P8, P10, P15, P20**
- Size Mode 24 x 100 cm  
**P4, P4.8, P6, P8, P10**

## 3. LED HOLOGRAPHIC FILM SCREEN

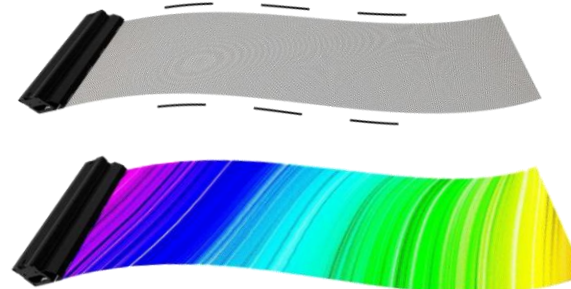

- Size mode 24 x 100 cm  
**P2.5, P3.91, P6.25**

## QSTech LED Videotron special size

Ratio 21:9

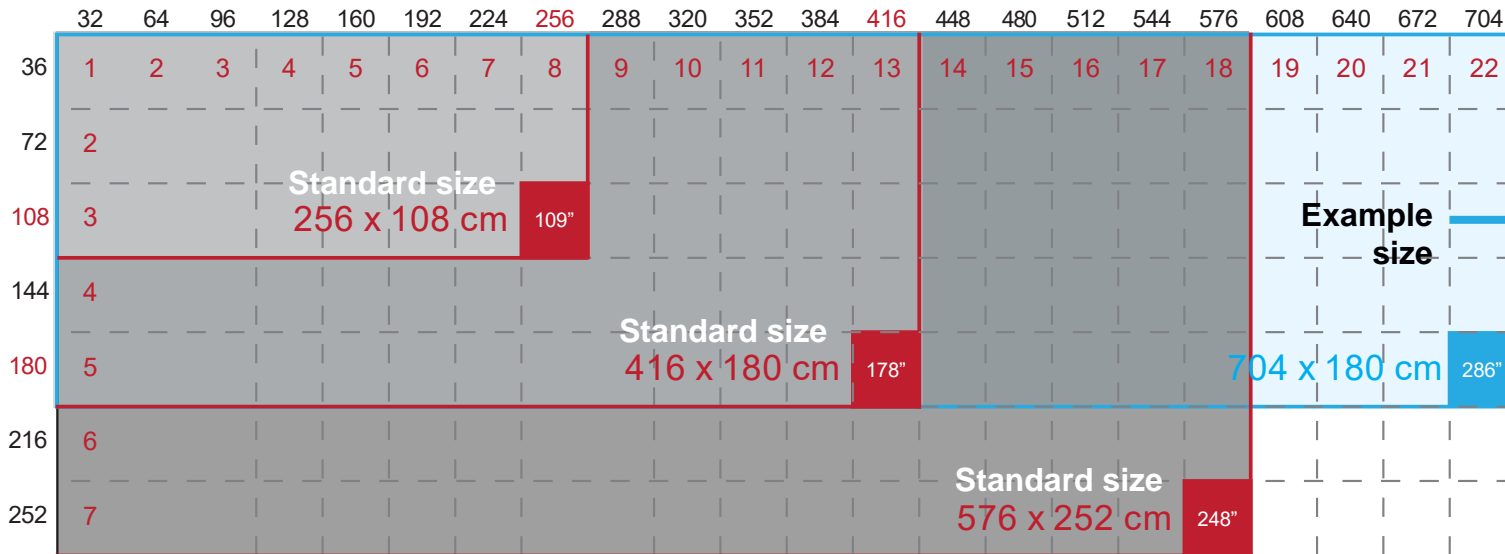

### Standard size 21:9:

- 109 Inch (256 x 108 cm)
- 178 Inch (416 x 180 cm)
- 248 Inch (576 x 252 cm)



### Example of proportion

- 248 Inch (576 x 252 cm)

## LCD special shape ICEBoard

Size 92 Inch Ratio 21:9



### General feature:

- Immense ultra-realistic display
- More flexible and more immersive
- IR Touch Display with Zero bonding
- Ultra-wide format
- 5K Resolution (5120x2160)
- Brightness 450 nits
- 7\*16 Hours
- RK3588 Android 13 (8G+64G)
- Color Temp sensor/Light sensor
- 80Pin OPS Slot
- 2.1 Channel Audio (2\*20W+20W)
- 8\*Mic
- WIFI Slot-Optional SI07B supports WiFi 6E
- Versatile Compatibility (Multi-functional USB Type-C)

### Case study :





**Other digital product solutions  
from InnoGRAPH**



**Digital teaching station** is a All-in-1 Platform digital classroom With integrated tools and software teaching tools

- Interactive sketcher (Touchscreen).
- Mini PC / NUC Intel WINDOWS Processor.
- Audio out to the speakers in the existing room.
- Ports for *HDMI OUT* to a projector screen / TV / LED Display VIDEOWALL atau Video Tron.
- Supporting Ports for USB data, USB remote pointer.
- Software *Note Whiteboard, Capture (Record) and Eshare.*

**Specification:**

- Metal body Finishing powder coating
- 16 inch display 10 point touch
- Intel N5105, Windows 10
- Visualizer document and Mic (optional)



**Dimension:**



**Suitable for:**  
Classroom, School, University.



**Suitable for:**  
 Press Conference,  
 Hall room, Houses of worship,  
 Lecture, Classroom.

**Digital Podium** is an All in One device specifically designed to make presentations, teaching, lectures and orations interactive.

- Interactive sketcher (Touchscreen).
- Mini PC / NUC Intel WINDOWS Processor.
- Audio out to the speakers in the existing room.
- Ports for *HDMI OUT* to a projector screen / TV / LED Display VIDEOWALL atau Video Tron.
- Supporting Ports for USB data, USB remote pointer.
- Software *Note Whiteboard, Capture (Record) and Eshare.*

**Specification:**

- Metal body Finishing powder coating
- 16 inch display 10 point touch
- Visualizer document and Mic
- Windows 10, Available in Intel i3, i5, i7

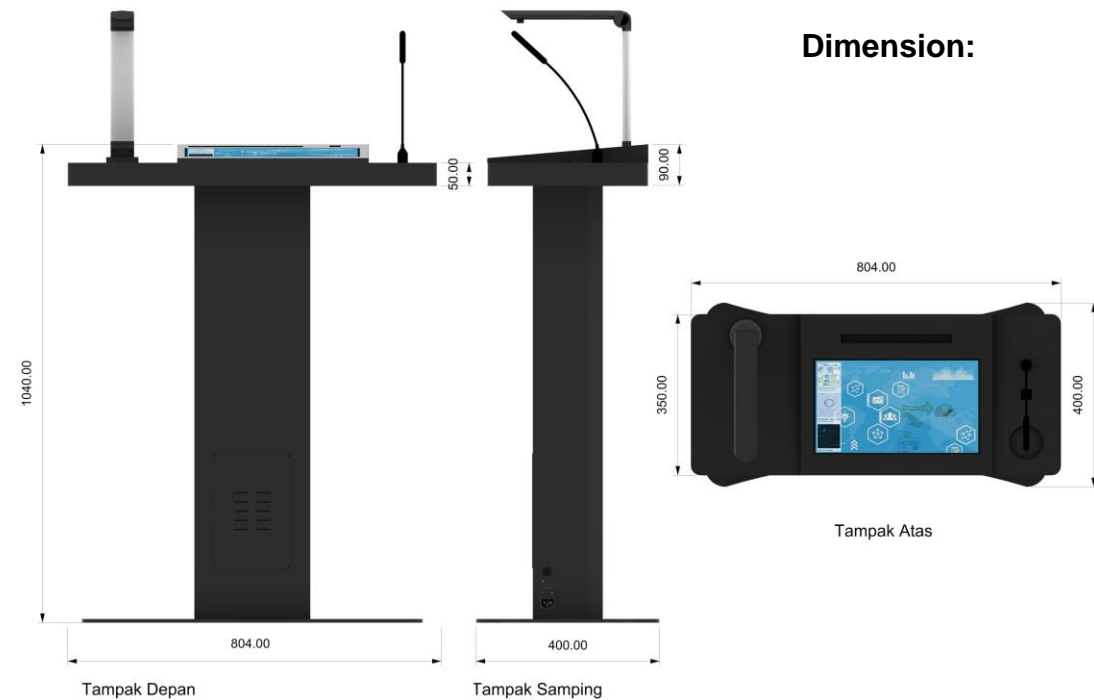



**Dimension:**

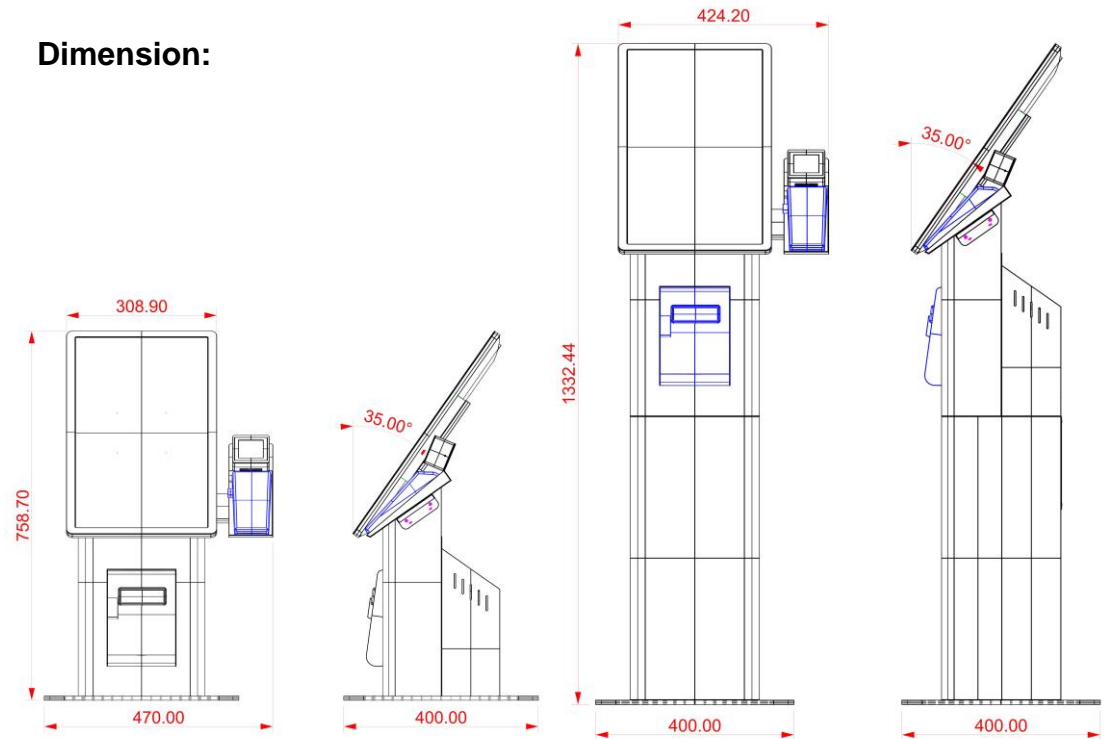

Desktop Type

Stand Type.

**Digisign Smart AI Order kiosk** is an intelligent device that we created to connect every part of the business, your operations and transactions.

- Two models available: Desktop Type & Stand Type.
- 21,5 Inch capacitive touch, QR code. Thermal printer.
- Attractive design & modern
- Iron frame finished with powder coating

**Specification:**

- Android 11 RK3568
- 250 Nits Brightness
- Network : Wifi, LAN
- Speaker: 5W\*2
- 10-Point capacitive touch
- Resolution 1920x1080
- Power Consumption 25W
- Ram/Memory : 2/16GB

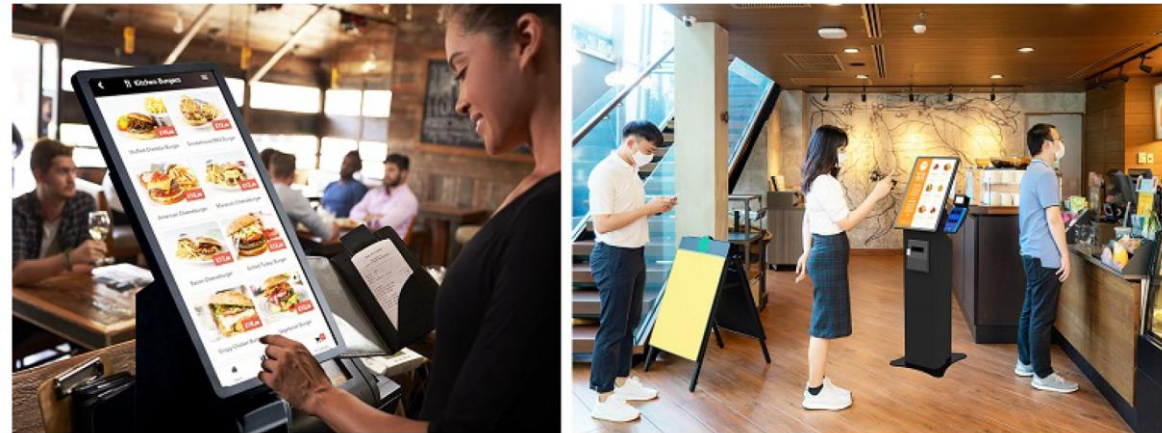

**Suitable for:**

Coffee Shop, Quick Service Restaurant, Café, Food & Beverage Business, etc.



scan me



ULTRA HD  
**4K**



40 POINTS  
TOUCH



ANTI GLARE



## Android system

## OPS Mini PC

Operation system	Android 11	Windows 11 IoT Enterprise
CPU	Amlogic T982 A55 x 4	Intel i5
RAM	8 GB	8 GB
ROM / SSD	64 GB	256 GB
Software Apps	Bytello OS, Bytello Share, Bytello DMS, Bytello Class	Windows

Our **ICEBOARD X** redefines meeting experiences. Designed to elevate meetings, our comprehensive solution empowers every participant to unleash their creativity and captivate audience

- Available in 75 & 86 inches
- Resolution 4K (UHD) for all sizes (75 & 86 inches) including Microphone, Subwoofer Speaker and Camera.
- Chipset Amlogic T982 Android 11 with 8GB RAM, 64GB ROM
- Bytello Ecosystem includes Bytello Share, Bytello OS, Bytello DMS, Bytello Class, and Bytello Class Pro.
- Account Management with Google Account / Microsoft Account integration using Bytello OS. Remote / Control Device IFP using Bytello DMS.
- Content sharing using Bytello Share up to 9 devices and broadcast feature to all devices on the same network.
- Copy Display to other IFP ICE Boards maximum 6 devices.
- Picture in Picture, Note Whiteboard, Share files via QR Code, Gmail / MS Account collaboration.



**Suitable for:**  
Meeting room, Class room



scan me





**Product display solutions  
from InnoGRAPH and  
customer support facilities**

## Project Reference



**Client:** Bank Mandiri/Mitra Adiperkasa  
**Product:** Samsung smart signage 32" & Philips 10" Touch  
**Project Volume:** 149 units  
**Timeline:** 2018 - 2019  
**Coverage:** Nationwide



**Client:** Mahkamah Agung Indonesia  
**Product:** Vestouch Android Interactive Kiosk  
**Project Volume:** 843 units  
**Timeline:** 2019  
**Coverage:** Nationwide



**Client:** PT Pegadaian Indonesia  
**Product:** Digital Floorstand  
**Project Volume:** 232 units  
**Timeline:** 2020  
**Coverage:** Jabodetabek

## Project Reference



**Client:** PT Transportasi Jakarta  
**Product:** SAMSUNG Edge-Lit 37" LED Stretched  
**Project Volume:** 251 units  
**Timeline:** 2019 - 2021  
**Coverage:** Jakarta



**Client:** Siloam Hospital  
**Product:** Digisign Self Service Kiosk & Self Order Kiosk  
**Project Volume:** 57 units  
**Timeline:** 2023  
**Coverage:** Nationwide

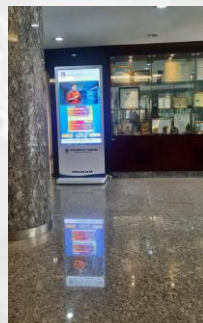

**Client:** Universitas Terbuka  
**Product:** Digital Floorstand 65 inch  
**Project Volume:** 54 units  
**Timeline:** 2021 - 2022  
**Coverage:** Nationwide

## Project Reference



**Client:** PT China Construction bank Indonesia  
**Product:** Digisign LED Display (Digitron) Indoor P1.8  
**Project Volume:** 1 unit; Size 3,20 x 1,8 m  
**Timeline:** 2023  
**Coverage:** Jakarta



**Client:** RS Mata JEC-Orbita  
**Product:** LED Display (Lampro) Indoor P2.5  
**Project Volume:** 1 unit; Size: 3,84 x 2,24 m  
**Timeline:** 2023  
**Coverage:** Makassar

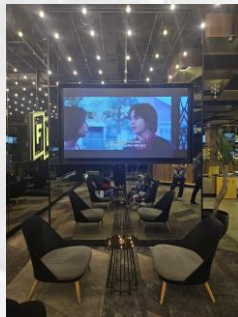

**Client:** PT Siname Agung Mandiri (Flix Cinema)  
**Product:** Digisign LED Display (Digitron) Indoor P1.8  
**Project Volume:** 1 unit; Size 1,92 x 1,08 m  
**Timeline:** 2023  
**Coverage:** Jakarta

# Other display solutions from InnoGRAPH



Backwall & Backdrop



Frame Stand



Event Desk



Lightbox



Building Sign

# Facilities



**Head Office**



**Meeting Room**

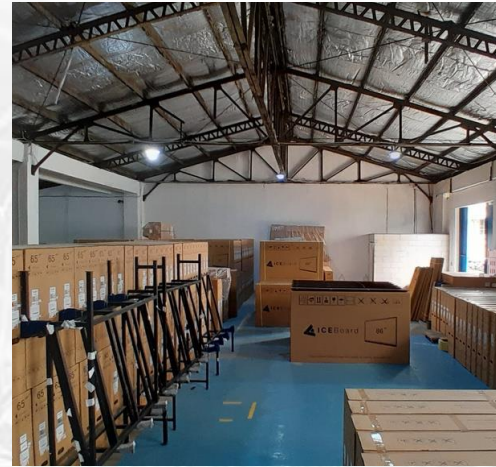

**Warehouse**



**Production & QC**

## Innovative Team



## Our Brands



**COME AND SEE OUR SHOWROOM**



**[www.innograph.com](http://www.innograph.com)**



**[www.displaystore.id](http://www.displaystore.id)**



**PT. Inovasi Sarana Grafindo**

Jl. Lenteng Agung Raya No. 15 Jakarta Selatan 12610 Indonesia.

**[cs@innograph.com](mailto:cs@innograph.com) WA: **+62 815 1028 2828****